

Spurlos wieder
entfernbar -
Empfohlen auch für
Mietwohnungen

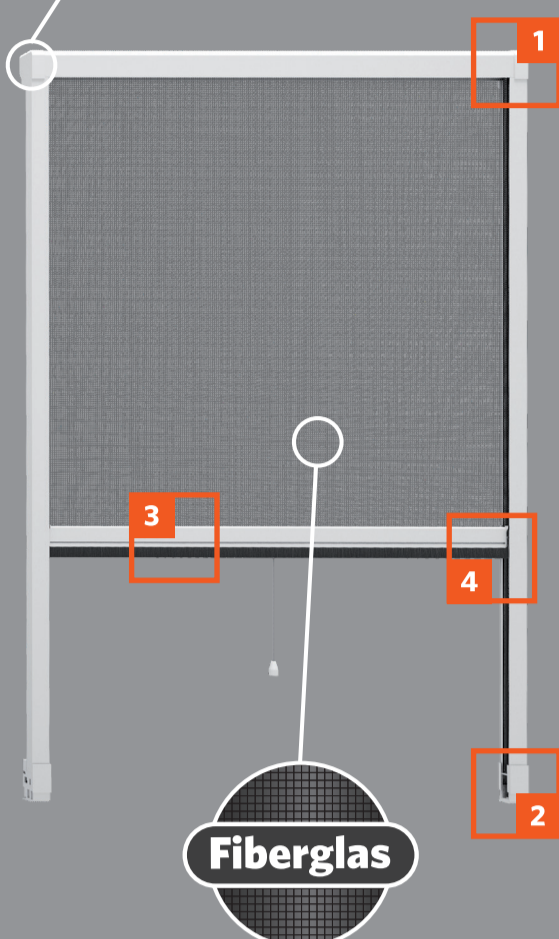

Fiberglas

Klemmtechnik

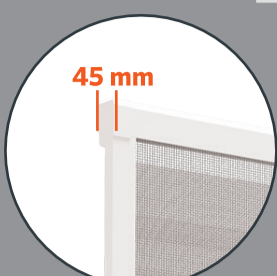

Klemmfuß mit Neigungsausgleich



easySTOP-Funktion

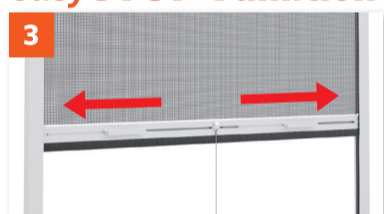

Rundumlaufende Dichtungsbürste



DE Rollo für Fenster

- 1+2 Klemmtechnik ohne Bohren und Schrauben am Mauerwerk möglich (Neigungsausgleich)
- 3 easySTOP-Funktion - Das Rollo ist in verschiedenen Höhen arretierbar. Speziell bei hohen Fenstern empfohlen
- 4 Dichtungsbürste - kein Spalt für Insekten

F Store moustiquaire enroulable pour fenêtres

- 1+2 Montage sans visser ni percer les murs (Compensation des inclinaisons)
- 3 Partiellement la moustiquaire d'ouvrir. Recommandée pour fenêtres hautes
- 4 Joint d'isolation en brosses pas de fente pour les insectes

I Tela insetti avvolgibile

- 1+2 Morsetto di installazione senza foratura /viti nella parete della muratura (Compensazione per inclinazioni)
- 3 Stop facile altezza con multi-level blocco easySTOP, Consigliato per finestre alte
- 4 Spazzole d'isolazione - nessun buco per gli insetti

NL Raamrolhor

- 1+2 Montage dankzij spantechnologie mogelijk zonder boren en schroeven op het metselwerk (Compensatie voor neigingen)
- 3 easySTOP-functie. Het hor is op meerdere hoogtes te arretieren, ideaal voor hoge raampartijen
- 4 Incl. afdichtingsborstel - geen opening voor insecten

S Rullgardin fönster

- 1+2 Spännteknologi gör att varken borring och skruvning behövs på väggen (Ersättning för luta)
- 3 easy-STOPP funktion gör att rullgardinen kan stanna vid önskad höjd. Speciellt rekommenderad för fönster
- 4 Tätningborste - inget mellanrum för insekter att ta sig in

CZ Okenní roleta proti hmyzu v hliníkovém rámu

- 1+2 Uchycení bez vrtání a šroubování do zdi (Kompenzace náklon)
- 3 Funke easySTOP - roletu lze zastavit v požadované poloze. Obzvláště vhodná pro vysoká okna
- 4 Těsnící kartáč zabraňuje průniku hmyzu

SK Okenná roleta proti hmyzu v hliníkovom ráme

- 1+2 Uchytienie bez vrtania a skrútkovania do steny (Kompenzacia náklon)
- 3 Funkcia easySTOP - roletu možno zastaviť v požadovanej polohe. Obzvlášť vhodná pre vysoké okná
- 4 Tesniaca kefa zabraňuje prúniku hmyzu

RO Rulou fereastră

- 1+2 Tehnologie de prindere fără foraj și fără șuruburi pe zidărie (Compensare pentru înclinare)
- 3 Funcția easySTOP - rulou poate fi blocat la diferite înălțimi. Recomandat în special pentru ferestre înalte
- 4 Perie de etanșare, nu permite pătrunderea insectelor

EN Roller blind window

- 1+2 Clamping technology mounting possible without drilling and screwing into the masonry (Compensation for inclinations)
- 3 easySTOP-function - The roller blind can be locked in various heights. Especially recommended for high windows
- 4 Sealing brush - no gap for insects



DE www.hornbach.de
AT www.hornbach.at
LU www.hornbach.lu
CH www.hornbach.ch
NL www.hornbach.nl
CZ www.hornbach.cz
SK www.hornbach.sk
RO www.hornbach.ro

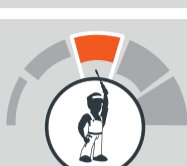

min. 1,5h 1x



45 mm

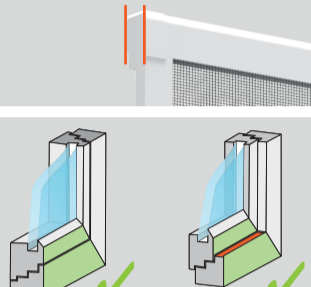

max. 125 x 170cm
min. 70 x 50cm

max. 125 x 170cm
min. 70 x 50cm

max. Bausatzgröße
taille max. du kit
dimensione massima del kit
max. grootte
max. storlek
max. veľkosť soupravy
dimensiunea maximă a setului
max. size of the assembly kit

max. Maueröffnung
ouverture max. du mur
apertura massima della parete
max. muuropening
max. väggöppning
max. otvor v stěně
max. otvor v stene
deschidere max. a peretelui
max. wall opening

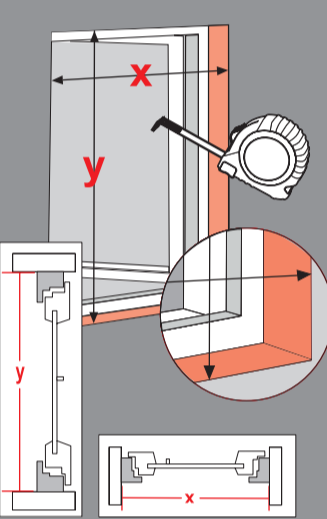

1. messen

mesurer měření
misurare meranie
meten meten
ätgård mēasuring

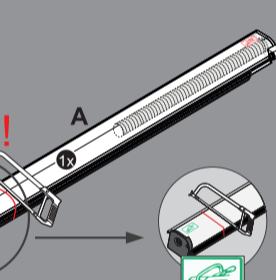

2. schneiden

couper tagliare
knippen knippen
klippa klippa

stříhání strihanie
tätät taitat
cutting cutting

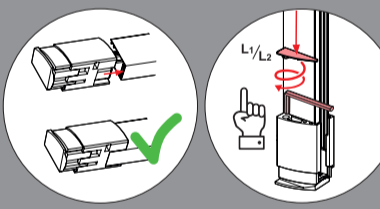

3. montieren

monter monter
montare montare
monteren montaj
montera mounting

CE	
24	
easy life GmbH Industriestraße 5 D-91583 Schillingsfürst	easy life
Artikel-ID: 580-3480	
DOP_580-3470,580-3472,580-3480, 580-3482,580-3490,580-3492 www.easy-life.de/kontakt,datenschutz-copy	
<p>Widerstand gegenüber Windlasten Résistance aux charges de vent Resistenza ai carichi del vento Weerstand tegen windbelasting Motslänskraft mot vindlast Odolnosť proti zaťaženi vätrem Odolnosť proti zafazeni vetrom Rezistența la vânt Resistance to wind loads</p>	
EN 13561:2015 / AC:2016	
<p>DE: Insektenzitter für den Außenbereich von Gebäuden F: Moustiquaires pour l'extérieur des bâtiments I: Zanzariere per l'esterno degli edifici NL: Insectenhorren voor de buitenkant van gebouwen. S: Insektnät för utsidan av byggnader CZ: Síť proti hmyzu pro exteriér budov SK: Sieť proti hmyzu pre exteriér budov RO: Plase împotriva insectelor pentru exteriorul clădirilor EN: Insect screens for the exterior of buildings</p>	

DE: Achtung! Plastiktüten sind kein Spielzeug. Bitte von Kindern fernhalten. Erstickungsgefahr! Getrennt entsorgen! Lokale Entsorgungsmöglichkeiten beachten.
F: Attention! Les emballages plastiques ne sont pas des jouets. Tenir à l'écart des enfants. Risque de suffocation. Jeter séparément - Observer les options d'élimination locales
I: Attenzione! Sacchetti di plastica non sono giocattoli. Tenere lontano dai bambini. Pericolo di soffocamento! Smaltire separatamente. Osservare le opzioni di smaltimento locali
NL: Let op! Plastic zakken zijn geen speelgoed. Vanwege verstikkingsgevaar weghouden bij kinderen en dieren. Afzonderlijk weggooien. Neem de plaatselijke verwijderingsmogelijkheden in acht
S: Varning! Plastpåsar är inga leksaker. Vänligen håll borta från barn. Risk för kvävning! Bortskaffa separat - Observera lokala möjligheter till avfallshantering
CZ: Upozornění! Plastový sáček není hračka. Udržujte mimo dosah dětí. Nebezpečí udušení! Likvidujte odděleně - Dodržujte místní možnosti likvidace
SK: Upozornenie! Plastové vrecko nie je hračka. Udržujte mimo dosahu detí. Nebezpečenstvo udušenia! Zlikvidujte oddelene. Dodržujte miestne možnosti likvidácie
RO: Atenție! Pungile de plastic nu sunt jucării. Vă rugăm să le păstrați departe de copii. Pericol de sufocare! Eliminați separat! Respectați posibilitățile locale de eliminare
EN: Warning! Plastic bags are not toys. Keep away from babies and children. Danger of Suffocation! Dispose of separately - Observe local disposal options



Made in: PRC
easy life GmbH
Industriestraße 5
91583 Schillingsfürst, Germany
info@easy-life.de
www.easy-life.de

home protect

Art.-Nr. 580-3480
Charge: MMXXIV-01



4 052329 007242

home protect



max. 125 x 170 cm
min. 70 x 50 cm



Rollo für Fenster

F Store moustiquaire enroulable pour fenêtres

I Tela insetti avvolgibile

NL Raamrolhor

S Rullgardin fönster

CZ Okenní roleta proti hmyzu v hliníkovém rámu

SK Okenná roleta proti hmyzu v hliníkovom ráme

RO Rulou fereastră

EN Roller blind window



www.blauer-engel.de/uz34