

# DAS 30 Variante

## Montageanleitung / Notice de montage / Assembly instruction

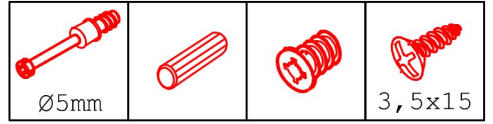

Ø5mm 12x  
34x  
16x  
3,5x15 8x

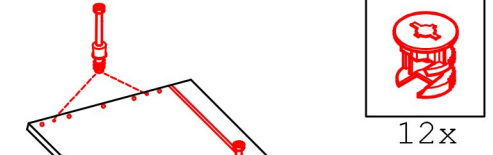

12x

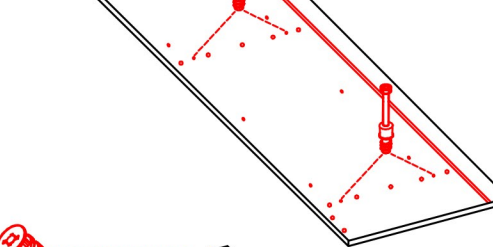

34x  
16x

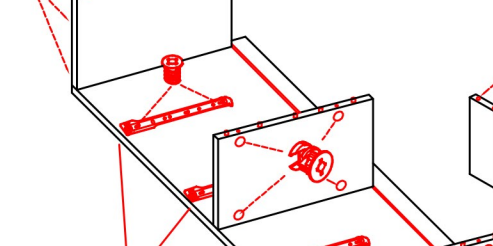

8x

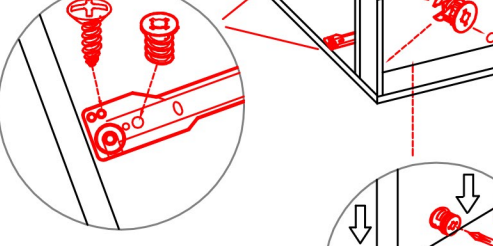

4,5x50 1x



4,5x15

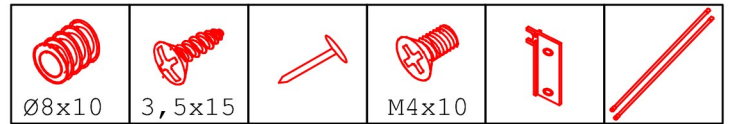

Ø8x10 16x  
3,5x15 48x  
15x  
M4x10 16x  
8x  
4x

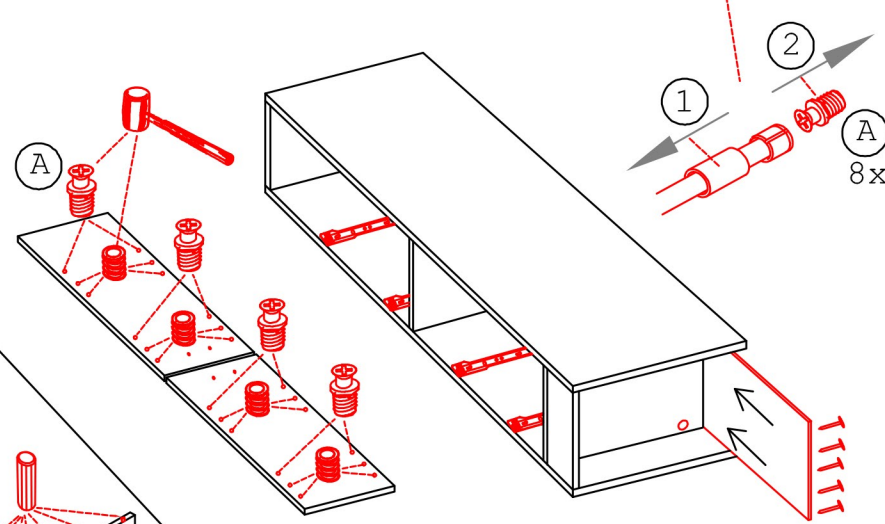

Ø8x10 16x  
3,5x15 48x  
15x  
M4x10 16x  
8x  
4x



M4x10 16x  
8x

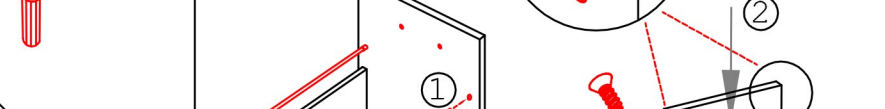

4x

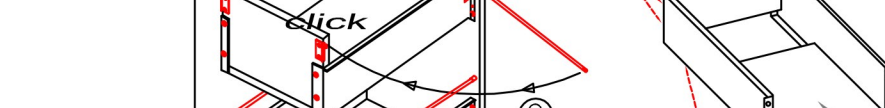

4,5x50 1x



4,5x15

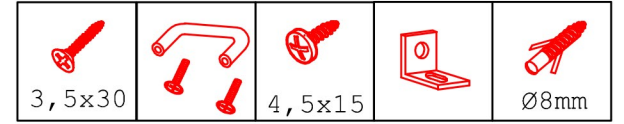

3,5x30 4x  
2x  
4,5x15 1x  
1x  
Ø8mm 1x

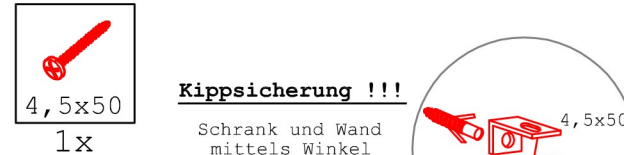

3,5x30 4x  
2x  
4,5x15 1x  
1x  
Ø8mm 1x



Ø8mm 1x

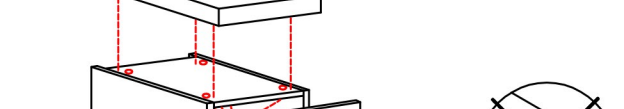

4,5x50 1x



4,5x15



4,5x50 1x

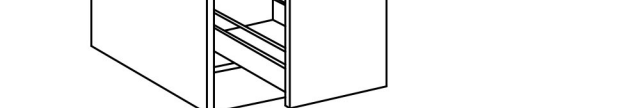

4,5x15

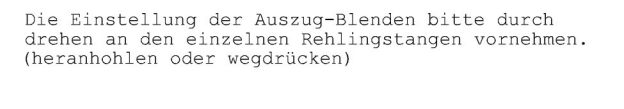

4,5x50 1x



4,5x15

**Klipsicherung !!!**  
Schrank und Wand  
mittels Winkel  
verbinden (unter dem  
oberen Boden)



4,5x50 1x  
4,5x15

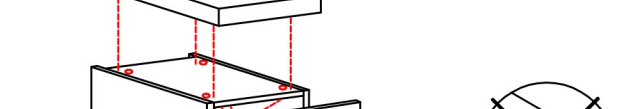

4,5x50 1x



4,5x15



4,5x50 1x

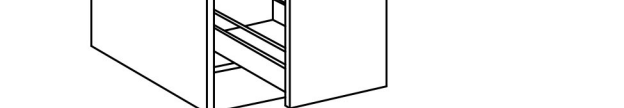

4,5x15

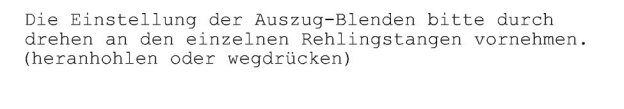

4,5x50 1x



4,5x15

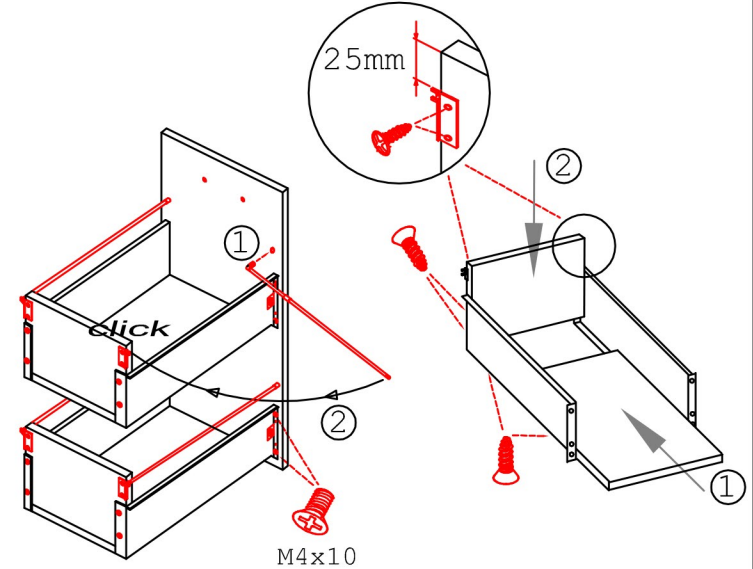

M4x10

Die Einstellung der Auszug-Blenden bitte durch  
drehen an den einzelnen Reihlingstangen vornehmen.  
(heranhohlen oder wegdrücken)