



decoflair®

feel at home



# Decke

Deckenleisten	S. 5 - 14
Innenecken für Deckenleisten	S. 10 - 11
Rosetten	S. 17
Deckenplatten	S. 18



# Wand

Wandleisten	S. 20 - 24
Vorgeschnittene Rahmen-Sets	S. 20
Viertelbögen für Wandleisten	S. 22
Wandverkleidung & Wandpaneele	S. 27 - 31



# Boden

Sockelleisten

S. 33 - 35



# Licht

Leisten für indirekte Beleuchtung

S. 37 - 38

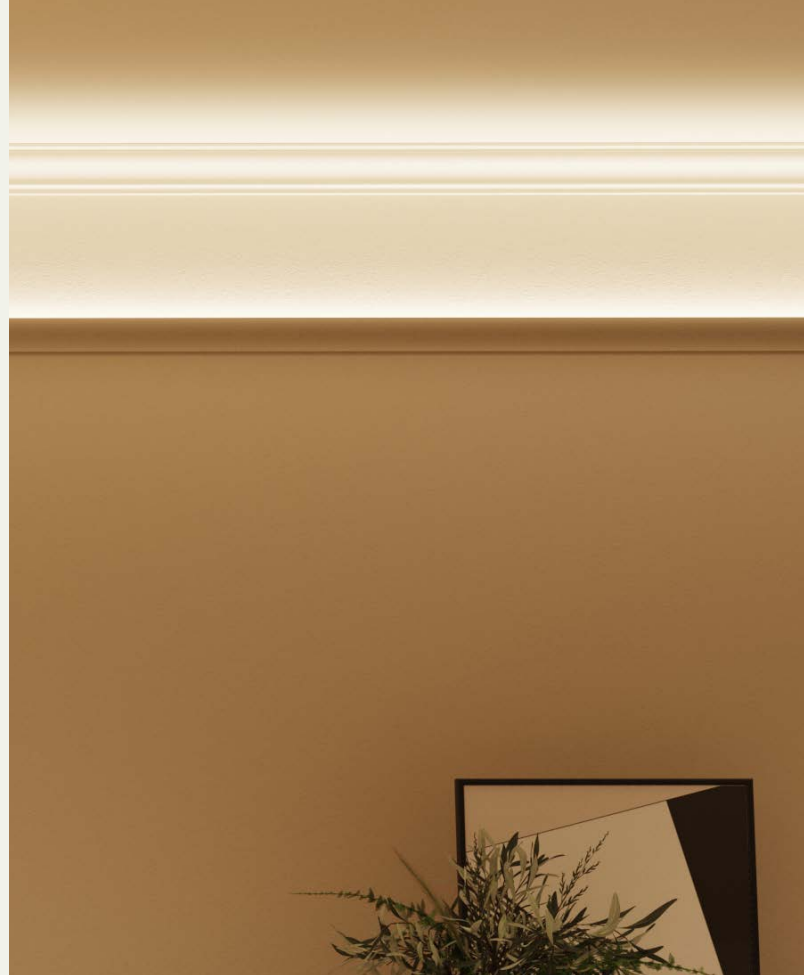

# Zubehör

Kleber & Werkzeug

S. 40

# Montage- Tutorials

S. 42 - 44



D13

# Decke

CL13

CP1



DECKENGESTALTUNG



C1

# Decken- leisten

Für jeden Geschmack  
das passende Design



C1

52 x 52 x 2000 mm



D13

49 x 42 x 2000 mm



Mehr Produkte unter [www.decoflair.com](http://www.decoflair.com)

# Decke

Für attraktive Akzente



D7

40 x 45 x 2000 mm



D8

50 x 50 x 2000 mm



D8





D7

C01

C4

M75

D17

C02

C12

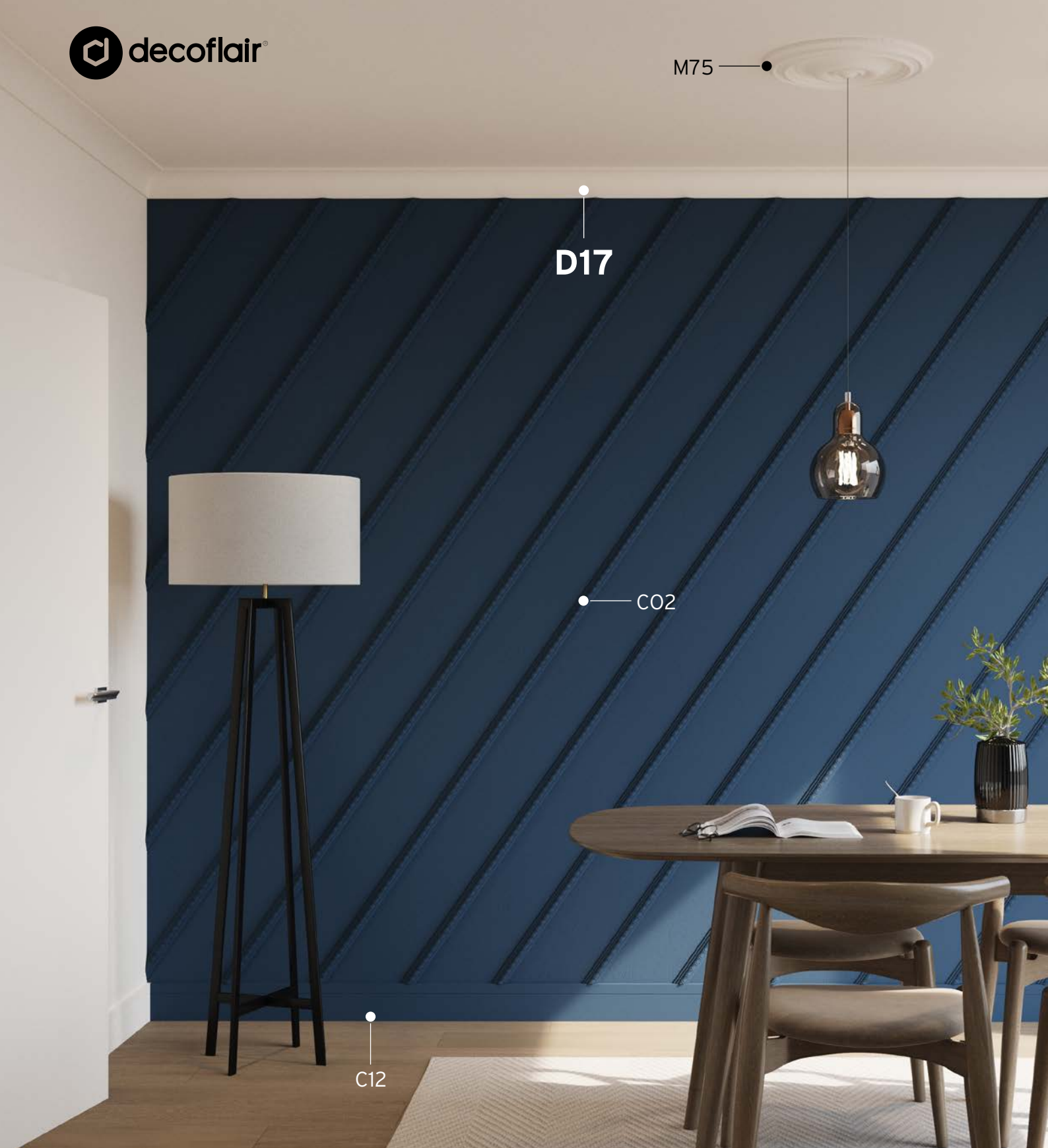



D20



50 x 50 x 2000 mm



D17



66 x 78 x 2000 mm

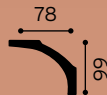

D10



80 x 80 x 2000 mm

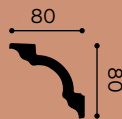

# Innen- ecken für Decken- leisten

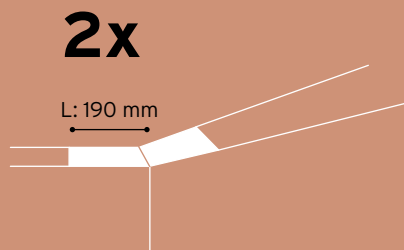

## D7 Innenecken

**NEU**

40 x 45 x 190 mm

⊕ D7 Deckenleiste

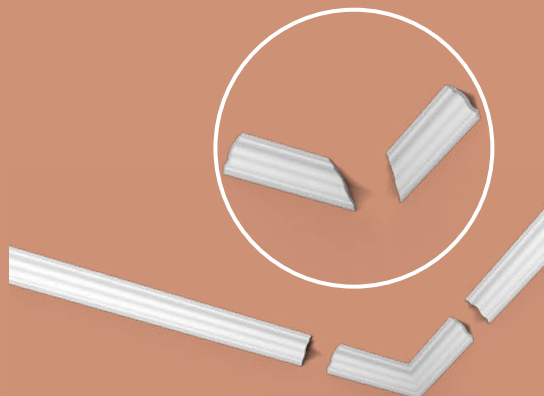

## D8 Innenecken

**NEU**

50 x 50 x 190 mm

⊕ D8 Deckenleiste

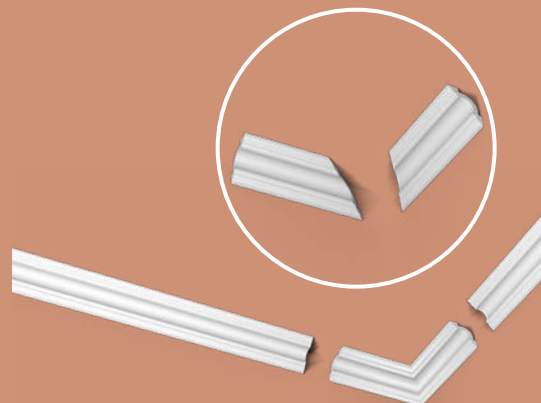



## D10 Innenecken

**NEU**

80 x 80 x 190 mm

⊕ D10 Deckenleiste

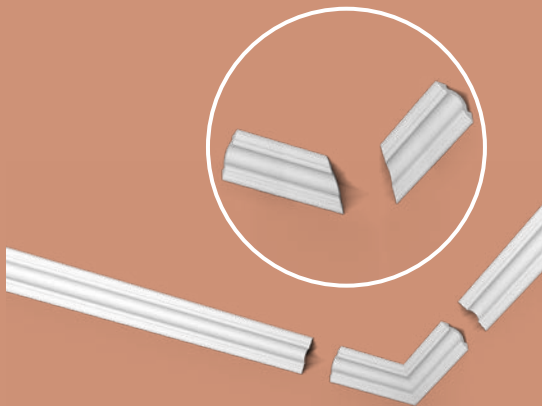
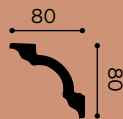

## D13 Innenecken

**NEU**

49 x 42 x 190 mm

⊕ D13 Deckenleiste

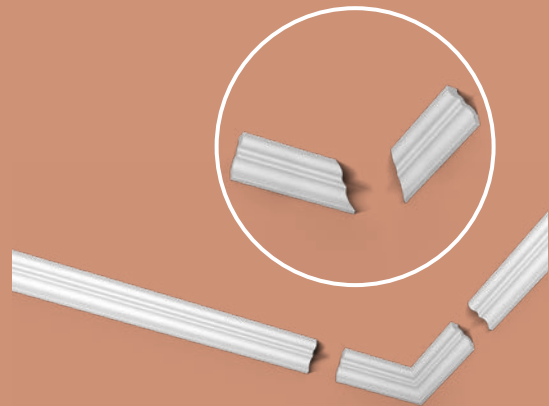



F5



Der Anstrich verleiht dem Profil  
einen individuellen Look.

F5



CL14



C12



# room kits

Die Komplettlösung



KOSTENSPAREND

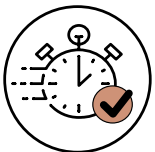

ZEITSPAREND

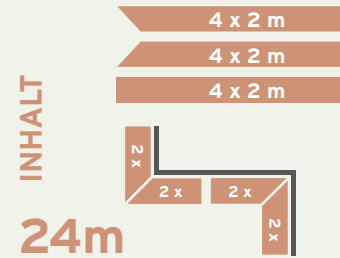

D7



40 x 45 x 2000 mm

D8



50 x 50 x 2000 mm

D10



80 x 80 x 2000 mm





M72

D13

C02

C4





**B17**

# Rosetten

Für den  
persönlichen Touch

**B33**



Ø 465 mm

**M62**

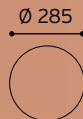

Ø 285 mm

**M72**



Ø 300 mm

Mehr Produkte unter [www.decoflair.com](http://www.decoflair.com)

• T149

# Decken- platten

T80



500 x 500 x 6 mm

T133



500 x 500 x 10 mm

T148



500 x 500 x 10 mm

T149



500 x 500 x 10 mm

# Wand

CO3

CL2

CBC3



WANDGESTALTUNG



C03

# Wand- leisten



CL1

38 x 16 x 2000 mm



C03

75 x 22 x 2000 mm



CL2

25 x 13 x 2000 mm



Mehr Produkte unter [www.decoflair.com](http://www.decoflair.com)

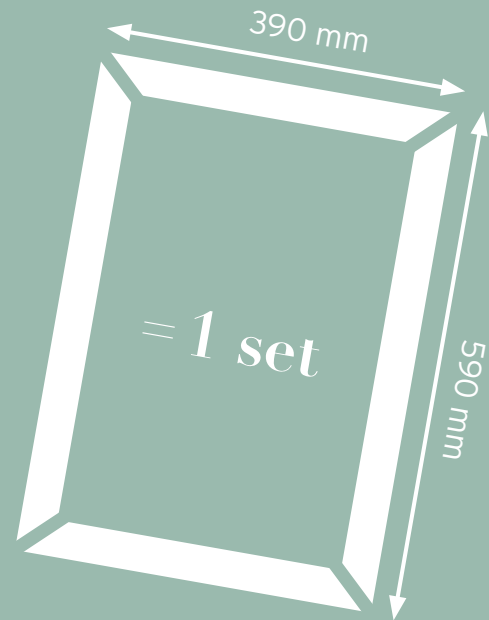

CL1 set	CL2 set
390 x 590 mm	390 x 590 mm

# Vorgeschnittene Rahmen-Sets

Gebrauchsfertig und leicht anzubringen



CL2  
Viertelbogen

# Viertel- bögen für Wand- leisten

CL1 **NEU**  
Viertelbogen



145 x 145 mm

⊕ CL1 Wandleiste



**4x**

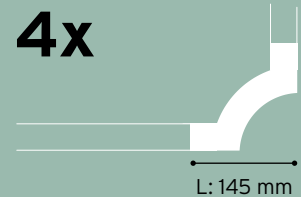

CL2 **NEU**  
Viertelbogen



130 x 130 mm

⊕ CL2 Wandleiste



**4x**

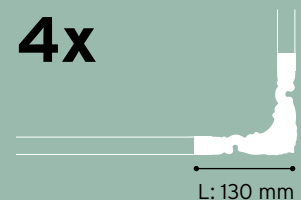



# room kit **NEU**

Die Komplettlösung



KOSTENSPAREND

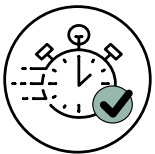

ZEITSPAREND



**3x**

**INBEGRIFFEN**

INHALT

4 x 2 m

4 x 2 m



16m

CL1



38 x 16 x 2000 mm





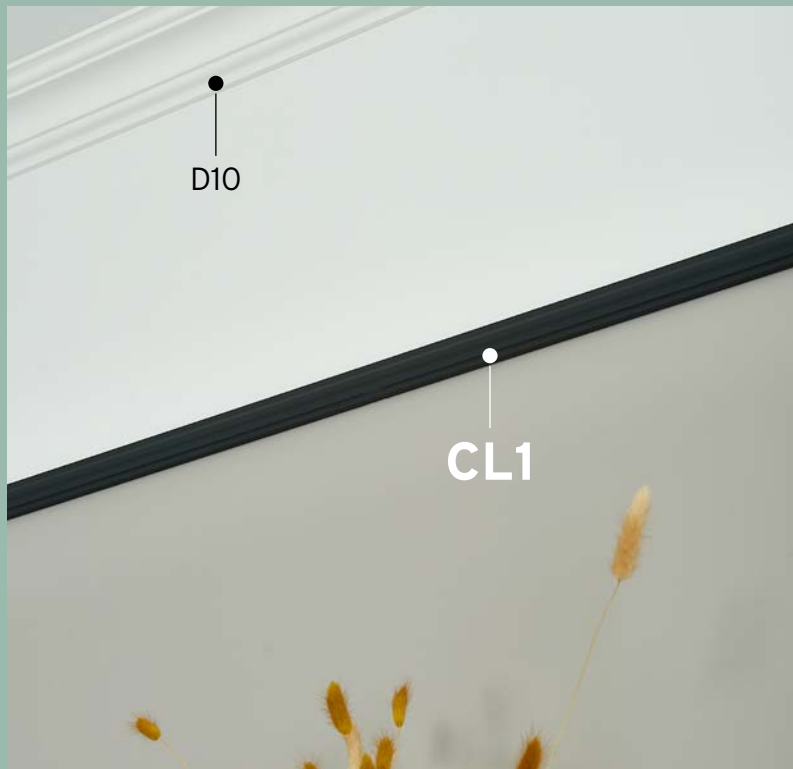



CL1



CBC3

# Wand- verkleidung



C03

CP1

C9

kombiniert mit  
CL13 s. 37

CP1



79 x 10 x 1220 mm

5er Pack

🔗 CL13, C9 Wandleisten





OCEAN —•

# Wand- paneele

OCEAN



380 x 760 mm

SAHARA



380 x 760 mm

SAHARA —●

CL14  
●

C12  
●





● — **BETON**

## STONE

500 x 1000 mm  
Art.-Nr. **3052711**



## IRON

500 x 1000 mm  
Art.-Nr. **3052712**



## MARBLE GREY

500 x 1000 mm  
Art.-Nr. **3052714**

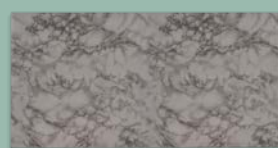

## BETON LIGHT

500 x 1000 mm  
Art.-Nr. **3052713**

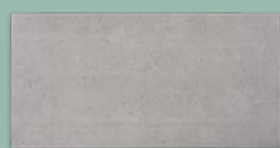

## MARBLE CREAM

500 x 1000 mm  
Art.-Nr. **3054000**



## STONE WALL BETON

500 x 1000 mm  
Art.-Nr. **3054001**



## • STONE WALL SILVER

## STONE WALL DARK GREY

500 x 1000 mm  
Art.-Nr. **3054002**



## STONE WALL WHITE

500 x 1000 mm  
Art.-Nr. **3054004**



## STONE WALL IRON

500 x 1000 mm  
Art.-Nr. **3054003**



## STONE WALL SILVER

500 x 1000 mm  
Art.-Nr. **3054436**



# Boden

C01 —●

C3  
|  
●



SOCKELLEISTEN





# Sockel- leisten

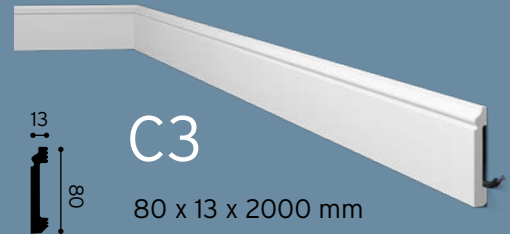

WASSERFEST



STOSSFEST



ÜBERSTREICHBAR



PLATZ FÜR KABEL



[www.blauer-engel.de/uz120](http://www.blauer-engel.de/uz120)

# Abdeck- Sockelleisten

Für die schnelle und einfache  
Renovierung

**CBC3**



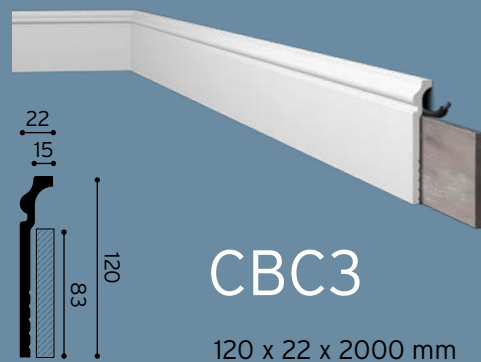
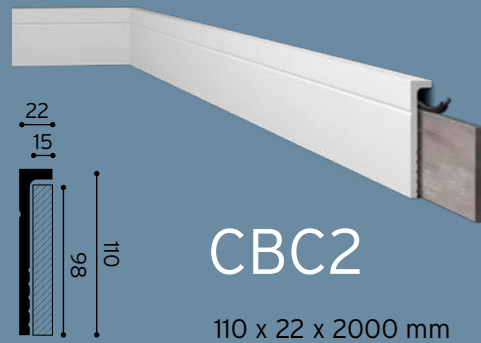
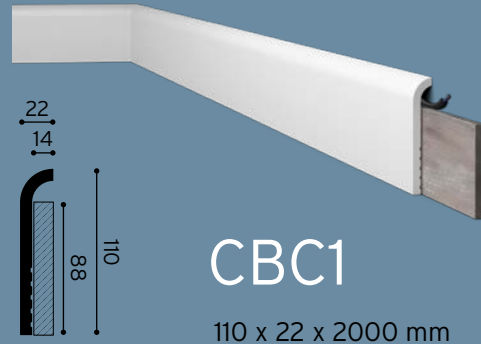

CL14

OCEAN

# Licht



LICHTLEISTEN



# Leisten für indirekte Beleuchtung

Schaffen eine warme Atmosphäre



CL11

50 x 33 x 2000 mm



CL13

55 x 18 x 2000 mm



CL12

60 x 36 x 2000 mm

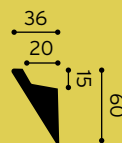

CL14

20 x 25 x 2000 mm



# room kit

Die Komplettlösung



KOSTENSPAREND



ZEITSPAREND



**3x**  
INBEGRIFFEN



INHALT

16m

2 x 2 m

2 x 2 m

4 x 2 m



CL11

50 x 33 x 2000 mm

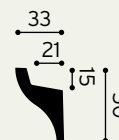

CL11

# Zubehör



KLEBER & WERKZEUG

# DECOFLAIR CM

CM500 310ml/570g  
 CM1000 1kg  
 CM5000 5kg



Ein perfektes Ergebnis  
 erfordert die richtigen  
 Mittel.

Abmessungen	Kleberverbrauch
<b>Leisten</b>	
21 x 17 mm → 45 x 45 mm	± 70 g / m
50 x 50 mm → 70 x 70 mm	± 100 g / m
80 x 50 mm → 90 x 100 mm	± 130 g / m
<b>Rosetten</b>	
Ø 80 mm	± 25 g / St.
Ø 90 → 400 mm	± 80 g / St.
Ø 420 → 660 mm	± 110 g / St.
<b>Deckenplatten</b>	
500 x 500 mm	± 250 g / m <sup>2</sup>

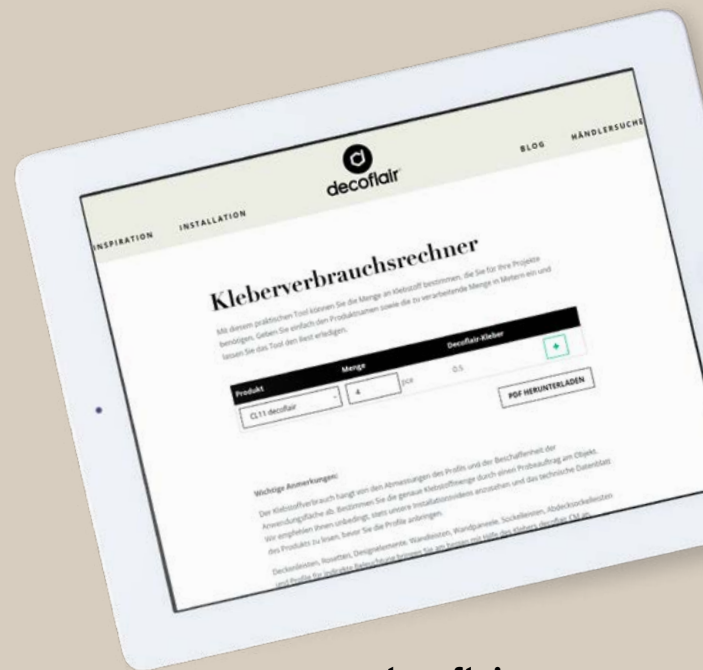

[www.decoflair.com](http://www.decoflair.com)



**MB1** 149 x 213 x 444 mm

**MB2** 82 x 154 x 350 mm





# Montage & Tutorials

# Montage & Tutorials

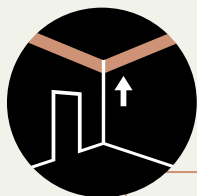

## DECKENLEISTEN



Scannen Sie den QR-Code,  
um das **Installationsvideo** zu entdecken!

## ROSETTEN



Alle  
Montage-Videos  
**online**

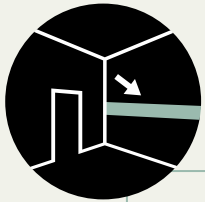

## WANDLEISTEN

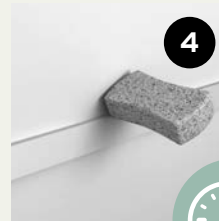
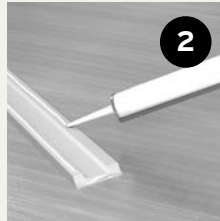

Scannen Sie den QR-Code,  
um das **Installationsvideo** zu entdecken!

## WANDFELDER



Scannen Sie den QR-Code,  
um das **Installationsvideo** zu entdecken!

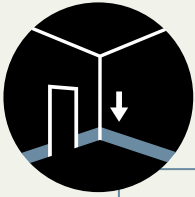

## SOCKELLEISTEN

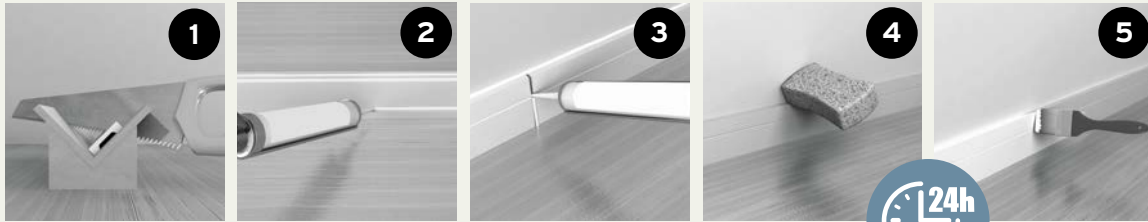

Scannen Sie den QR-Code,  
um das **Installationsvideo** zu entdecken!



## LICHTLEISTEN



Scannen Sie den QR-Code,  
um das **Installationsvideo** zu entdecken!

# Nach- haltigkeit

## Eine (d)eco-freundliche Vorgehensweise

Wenn Umweltschutz und nachhaltiger Konsum zu Ihren Prioritäten gehören, dann haben wir schon einiges gemeinsam. **decoflair®** ist eine Marke der NMC-Gruppe und bei NMC stellen wir die nachhaltige Entwicklung und den Wohlstand zukünftiger Generationen in den Mittelpunkt unseres täglichen Handelns.

Bereits in den 1980er Jahren war NMC ein Pionier in Sachen Nachhaltigkeit und wurde zum ersten Unternehmen seines Bereiches, das den Einsatz von FCKWs (ozonschädigende Gase) abschaffte und mit dem Recycling seiner Rohstoffe begann. Seitdem aktualisieren wir ständig unsere Management- und Produktionssysteme, um die Auswirkungen auf die Umwelt zu verringern.



Die dekorativen Elemente von **decoflair®** werden unter fairen Bedingungen in Belgien und Deutschland hergestellt und bedienen größtenteils europäische Märkte, wodurch der durch den Transport verursachte CO<sub>2</sub>-Ausstoß begrenzt wird.

Unsere Hauptproduktionsstätte in Belgien besitzt eine der größten Photovoltaikanlagen in der Wallonie (B).

Die Anlage verfügt über eine Produktionskapazität von 2200 MWh/Jahr, was dem durchschnittlichen Jahresbedarf von 827 belgischen Haushalten entsprechen würde.

Insgesamt zählen wir 39.559 m<sup>2</sup> Solarpaneele auf dem Boden und auf Dächern unserer Hallen. Das entspricht der Fläche von 5,5 Fußballfeldern.

97% des Wassers, das für die Herstellung der extrudierten Dekorelemente verwendet wird, wird recycelt und im nächsten Produktionszyklus wiederverwendet. So operieren wir mit geschlossenen Wasserkreisläufen, um unseren Verbrauch und die Wasserverschmutzung zu minimieren.



Wir recyceln nahezu 100% der Polymer-Abfälle in unseren eigenen Anlagen. Die beschädigten Profile werden geschreddert und im nächsten Produktionszyklus als Rohstoff wiederverwertet.



Wir engagieren uns für "Operation Clean Sweep", durch die wir, den unbeabsichtigten Verlust von Granulat und Pulver aus unseren Rohstoffen vermeiden und so verhindern, dass diese in die Wasserwege und das Meer gelangen.



Alle unsere Deckenleisten, Sockelleisten, Rosetten, Design Elemente, Leisten für indirekte Beleuchtung, Wandpaneele, Wandleisten und Deckenplatten werden zu 100% mit grünem Strom hergestellt.



Wir geben unser Bestes um die Umweltauswirkungen unserer Verpackungen zu reduzieren. Unter anderem werden die Schutzfolie sowie die Etiketten der Profile zu 30% aus recycelten Materialien hergestellt.



[www.blauer-engel.de/uz120](http://www.blauer-engel.de/uz120)

Die **decoflair**<sup>®</sup> Sockelleisten und Abdecksockelleisten sind mit dem deutschen Qualitätssiegel "Blauer Engel" als emissionsarm und gesundheitlich unbedenkliche Produkte ausgezeichnet worden.



[www.decoflair.com](http://www.decoflair.com)

*Scannen Sie den QR-Code auf der Produktverpackung  
und erhalten Sie mehr Informationen:*



- **Produktdetails**
- **Installationsvideos**
- **Kleberverbrauchsrechner**



5 412938 955850